

Discontinued ●
Discontinued when stock = 0 +

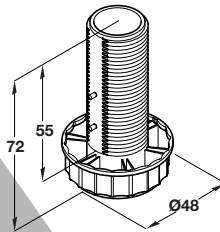
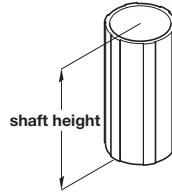
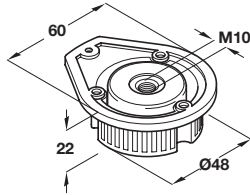

- **A Plinth feet sets**
- For plinth heights 100 and 150 mm
- Set consists of:
 - 1 x 637.96.341 or 637.96.343 - Shaft section, black plastic
 - 1 x 637.96.350 - Foot section, black plastic
 - 1 x 637.96.361 - Top section, screw mounting, black plastic

A Plinth feet sets

Shaft height	Cat. No.	
63.5 mm	637.96-0010	APP
105.5 mm	637.96-0011	

Packing: 1 set

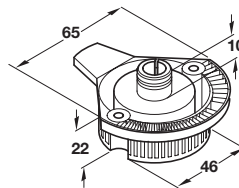

- **C Top section, screw mounting**
- For screw fixing to or through cabinet base
- Black plastic

C Top section, screw mounting

Cat. No.	+ 637.96-0015
----------	---------------

Packing: 500 pc

Initial delivery

Pending Inspection by:

Goods In:

.....Date.....

Purchasing:

.....Date.....

Issue Approved by:

.....Date.....

D Plinth clip and bracket

- Pres fixing
- Black plastic

Cat. No. 637.96-0028 APP

Order qty: 1 pc

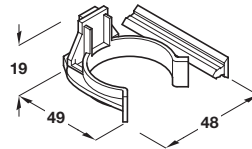

E Top section, dowel mounting

- With Ø 15 mm spreading dowel for fixing to underside of cabinet base
- Bulk packed, 4850 per box
- Black plastic

Cat. No. 637.96-0026

Order qty: 4850 pcs

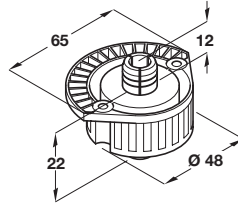

F Foot and shaft sections

- For plinth heights 150 mm
- Bulk packed, 1900 per box (2 boxes per pallet)
- Black plastic

Cat. No. 637.96-0027

Order qty: 1900 pcs

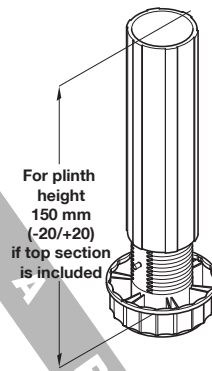

G Plinth feet set, dowel fixing

- For plinth height 100 mm
- With Ø15 mm spreading dowel for fixing to the underside of cabinet bases
- Black plastic

Item	No. of items included
Top section	2 pcs
Foot and shaft	2 pcs
Plinth clip and bracket	2 pcs
Cat. No.	637.96-0033 APP

Order qty: 1 set

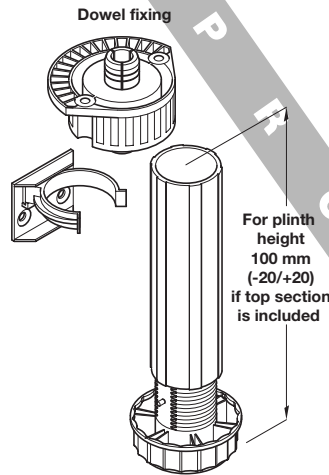

NOT APPROVED

Initial delivery

Pending Inspection by:

Goods In:

.....Date.....

Purchasing:

.....Date.....

Issue Approved by:

.....Date.....

H Plinth connecting profile

- For 19 mm thick plinth panel
- Plastic

Finish	Cat. No.
Black	239.97-0007

Order qty: 2 m lengths

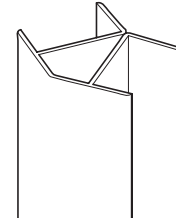
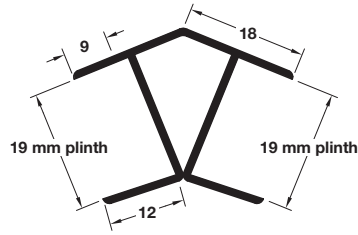

N O T A P P R O V E D

8

Initial delivery
Pending Inspection by:
Goods In:
.....Date.....
Purchasing:
..... Date.....
Issue Approved by:
..... Date.....