

STANDARD 95°/100° HINGES



- > Opening angle 95°/100°
- > Full overlay, half overlay/twin or inset mounting
- > Sprung
- > Ø 35 mm cup
- > For door thickness up to 30 mm (95°) and up to 24 mm (100°) see table right
- > Screw fixing or dowel fixing cup
- > Choice of slide on or click on arms
- > Soft close compatible
- > Cup: Nickel-plated pressed steel
- > Arm: Nickel-plated pressed steel
- > Order qty: 1 pc

-  > Mounting plates for slide on and click on hinges shown on pages **110-113**
- > Hinge cover plates shown on page **111**
- > Soft close shown on page **114**

95° Full overlay mounting

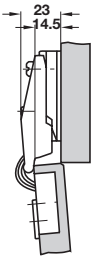

Door overlay mm						
14	15	16	17	18	19	
			4	5	6	0
	4	5	5			2
Distance to cup E mm			Mounting plate height mm			



Fixing	Slide on	Click on
Screw fixing	323.11.505	322.11.530

95° Half overlay/twin mounting

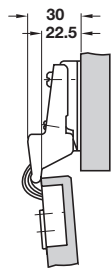

Door overlay mm						
6	7	8	9	10	11	
			4	5	6	0
	4	5	6			2
Distance to cup E mm			Mounting plate height mm			



Fixing	Slide on	Click on
Screw fixing	323.11.514	322.11.531

95° Inset mounting

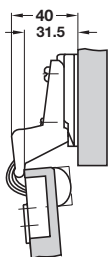

Door gap mm			
	0	1	2
	4		2
	6	5	4
Distance to cup E mm		Mounting plate height mm	



Fixing	Slide on	Click on
Screw fixing	323.11.523	322.11.532

LIFT, TURN AND SLIDE 2013, © Häfele U.K. Ltd 2013. Dimensional data not binding. We reserve the right to alter specifications without notice.

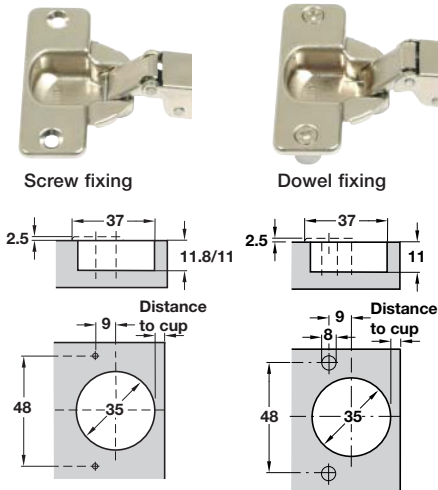

95 Hinge

Door thickness mm	Distance to cup E mm			
	3.0	4.0	5.0	6.0
16	0.1	0.1	0.1	0.1
18	0.2	0.2	0.2	0.2
19	0.3	0.3	0.3	0.3
20	0.4	0.4	0.4	0.4
22	0.7	0.7	0.7	0.7
24	1.0	1.0	1.0	1.0
26	1.4	1.4	1.4	1.4
28	1.9	1.9	1.9	1.9
30	3.8	2.9	2.6	2.5
Minimum gap				

100° Hinge

Door thickness mm	Distance to cup E mm			
	3.0	4.0	5.0	6.0
16	0.6	0.6	0.6	0.6
18	0.9	0.9	0.9	0.9
19	1.1	1.1	1.1	1.1
20	1.4	1.4	1.4	1.4
22	1.9	1.9	1.9	1.9
24	2.5	2.5	2.5	2.5
Minimum gap				

100° Full overlay mounting

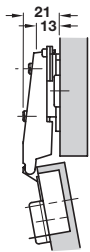

Door overlay mm	Mounting plate height mm						
	14	15	16	17	18	19	
				4	5	6	0
		4	5	5			2
Distance to cup E mm							



Fixing	Slide on	Click on
Screw fixing	323.40.500	322.15.540
Dowel	-	322.15.590

100° Half overlay/twin mounting

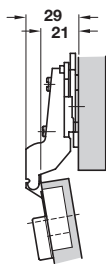

Door overlay mm	Mounting plate height mm						
	6	7	8	9	10	11	
				4	5	6	0
		4	5	6			2
Distance to cup E mm							



Fixing	Slide on	Click on
Screw fixing	323.40.501	322.15.541

100° Inset mounting

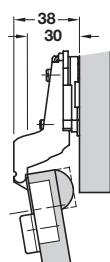

Door gap mm	Mounting plate height mm			
	0	1	2	
	4		2	
	6	5	4	4
Distance to cup E mm				



Fixing	Slide on	Click on
Screw fixing	323.40.502	322.15.542