

STANDARD 92° GLASS DOOR HINGES

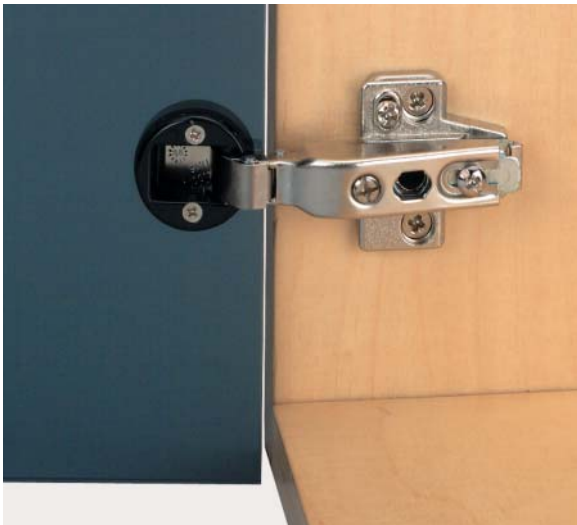

- > Opening angle 92°
- > Full overlay, half overlay or inset mounting
- > Sprung
- > Ø 26 mm cup
- > Screw fixing cup
- > Suitable for 4-6 mm glass
- > Slide on or click on arms
- > Cup: Black plastic
- > Arm: Full overlay mounting: Nickel-plated pressed steel
Half overlay/inset mounting: Nickel-plated zinc alloy
- > Order qty: Multiples of 10 pcs

Screw fixing

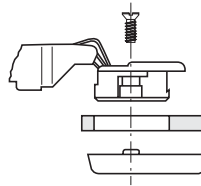
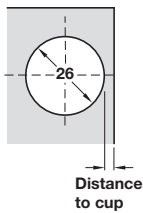

For glass thickness 4-6 mm
For safety reasons we recommend that toughened glass be used with these hinges



- > Mounting plates for slide on and click on hinges shown on pages **110-113**
- > Hinge cover plates shown on page **111**

Full overlay mounting

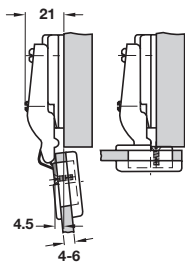

Door overlay mm							
13	14	15	16	17	18	19	
				4	5	6	0
		4	5	6			2
Distance to cup E mm				Mounting plate distance mm			
Fixing		Slide on		Clip on			
Screw fixing		323.37.303		322.37.330			

LIFT, TURN AND SLIDE 2013, © Häfele U.K. Ltd 2013. Dimensional data not binding. We reserve the right to alter specifications without notice.

Half overlay/twin mounting

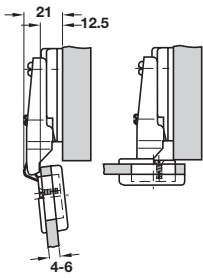

Door overlay mm							
5	6	7	8	9	10	11	
				4	5	6	0
		4	5	6			2
Distance to cup E mm				Mounting plate distance mm			

Fixing	Slide on	Click on
Screw fixing	323.37.312	322.37.331

Inset mounting

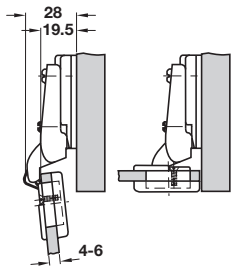

Door gap mm						
	4	3	2	1	0	
					4	2
			4	5	6	4
Distance to cup E mm				Mounting plate distance mm		

Type	Slide on	Click on
Screw fixing	323.37.321	322.37.332

Cover caps

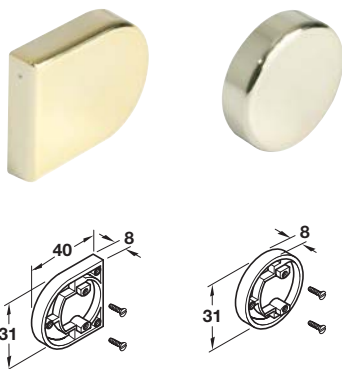

- > Plastic
- > Order qty: 1 pc (*multiples of 10 pcs)



Finish	D shaped	Round
Polished brass	324.05.824	324.05.833
Polished chrome	324.05.726	324.05.735
Satin nickel	324.05.628	324.05.637*